

1T8590DA | CTEVO ARCHITECTURAL 160

Adjustable recessed LED projector in a trim version

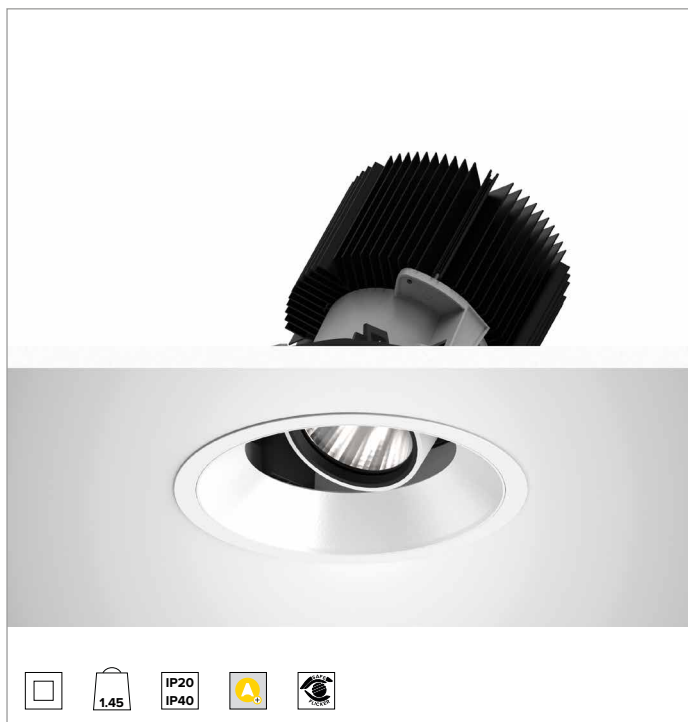

		3500K	H(m)	D(m)	E _{max} (lx)
		Ra90		22°	
		Fixture Power	74W	1	0.39 23707
		Source Flux	7803lm	2	0.77 5927
		Fixture Flux	5272lm	3	1.16 2634
		Efficacy	72lm/W	4	1.55 1482
TS1280	I _{max} =3038cd/klm	I _{max}	23707cd	5	1.94 948

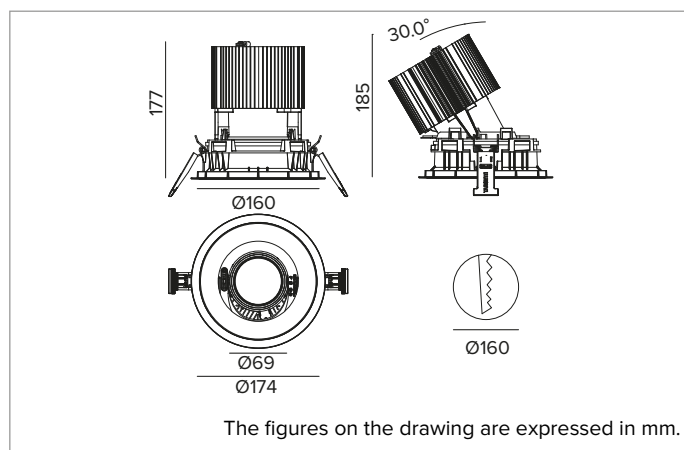

SOURCE

High efficiency Chip on Board LED Ra90. Ra80 on request.

Energy efficiency class: E

Nominal power: 66W

Nominal flux: 7803lm

Colour rendering index: 90

Rf: 91

Rg: 100

CCT nominal: 3500K

Lifetime (L80/B10): >50000h tq +25°C

ILLUMINOTECHNICAL CHARACTERISTICS

SP - precision optics with a black silicone cut off ring. Version with a convex faceted highly reflective anodised aluminium reflector and a holographic diffusion filter. UGR<19 (EN 12464-1).

Optic: REFLECTOR

Beam angles: SP

Optical efficiency: 68%

Fixture flux: 5272lm

Luminous efficacy: 72lm/W

Photobiological safety: Compliant with RG1 low risk group

MECHANICAL CHARACTERISTICS

Die-cast white painted anodised aluminium body and dissipator. White colour cover. The optical unit can be adjusted up to 30° on the vertical plane with a mechanical beam locking system and a graduated scale, and 358° on the horizontal plane. Trim version with an integrated white ring.

Colour and finish: Plaster white

Weight: 1.45Kg

Version: TRIM HO

Degree of protection: IP20 for recessed part

Degree of protection: IP40 for exposed part

ELECTRICAL CHARACTERISTICS

Integrated DALI driver. Luminaire compliant with EN 60598-2-22 for power supply from a centralised emergency system CPSS (Central Power Supply System), not incorporated in the luminaire - high risk areas excluded. The default power and flux are 100% in AC and 15% in DC.

Fixture Power: 74W

Power supply: 220-240Vac 50/60Hz

Insulation Class: CLASS 2

Type of driver / Control: DALI - PUSH

Driver included: YES

Class F: YES

SAFE FLICKER: PstLM=<1 and SVM=<0.4 (IEC TR 61547-1 and IEC TR 63158), to ensure a more comfortable and safe light

Ambient temperature: 0°C / +25°C

INSTALLATION

Quick tool-free mounting system for false ceiling installation from 0.5 to 30mm.

NOTES

Casambi control system available using a dedicated accessory. 110-277Vac version available on request. Commissioning of the control system via free APP; the intervention of a specialist technician can be quoted on request.

WARRANTY

5 years.

WARNING

Luminaire designed for disposal/recycling at end-of-life. Replaceable (LED only) light source by a professional. Replaceable control gear by a professional.

Due to the technological evolution of the electronic components, the data provided may be updated, and as such, confirmation must be requested during the order process.

Luminous flux and power supply have +/-10% tolerances with respect to the indicated value. tq +25°C (CIE 121).

We reserve the right to make technical changes.

Targetti Sankey S.r.l.
Via Pratese, 164
50145 Firenze - Italy
Tel: +39 055 37911
targetti.com
targetti@targetti.com

CCIAA Firenze
Share Capital:
€ 500.000,00
VAT N. (IT):
01537660480
R.E.A.: FI-275656

TARGETTI

1T8590DA | CTEVO ARCHITECTURAL 160

Adjustable recessed LED projector in a trim version

Accessories

Mounting System



L mm	Code
------	------

2500	1T9606
------	---------------

Anti-fall safety cable to secure the body of the appliance to the building structure.

Control systems



Code

1T5349

IP20 wireless control unit with DALI interface.

It generates a local DALI2 bus, enabling a direct connection to a DALI interface LED driver.

The module can only be used in a closed system and cannot be connected to an existing DALI network.

The module is wireless controlled using a Casambi app for smartphones and tablets using Bluetooth 5.0 technology.

The devices automatically create an adaptive, robust, and reliable wireless mesh network, allowing for the easy and efficient management of a high number of fixtures.

The control unit is preset to the DALI 1CH profile, meaning the device can control a single DALI driver with broadcast commands.

In addition to the DALI broadcast, other operating modes are available, such as:

- Button (normally open)
- Control unit 0/1-10V
- Control unit DALI Tunable White DT8
- Presence sensor



Code

2T0131

IP20 Extender for wireless control of LED driver with dimming DALI (or 1-10V) interface based on Casambi technology.

It has a DALI2 output with the capacity to control up to 40 lighting fixtures.

With the addition of a further external BUS DALI power supply it is possible to control up to 64 fixtures.

IP20 Extender is preset to the DALI broadcast profile, meaning all the luminaires connected to it are dimmable at the same level.

In addition to the DALI broadcast other operating modes are available, such as:

- EXTENDER DALI 8CH
- EXTENDER DALI Tunable White
- EXTENDER 0/1-10V
- EXTENDER DALI 4CH
- EXTENDER DALI DT8 Tunable White

Due to the technological evolution of the electronic components, the data provided may be updated, and as such, confirmation must be requested during the order process.

Luminous flux and power supply have +/-10% tolerances with respect to the indicated value. tq +25°C (CIE 121).

We reserve the right to make technical changes.

Targetti Sankey S.r.l.
Via Pratese, 164
50145 Firenze - Italy
Tel: +39 055 37911
targetti.com
targetti@targetti.com

CCIAA Firenze
Share Capital:
€ 500.000,00
VAT N. (IT):
01537660480
R.E.A.: FI-275656

TARGETTI